

MARK 31B SOLID STATE STEREO AMPLIFIER SERVICE MANUAL

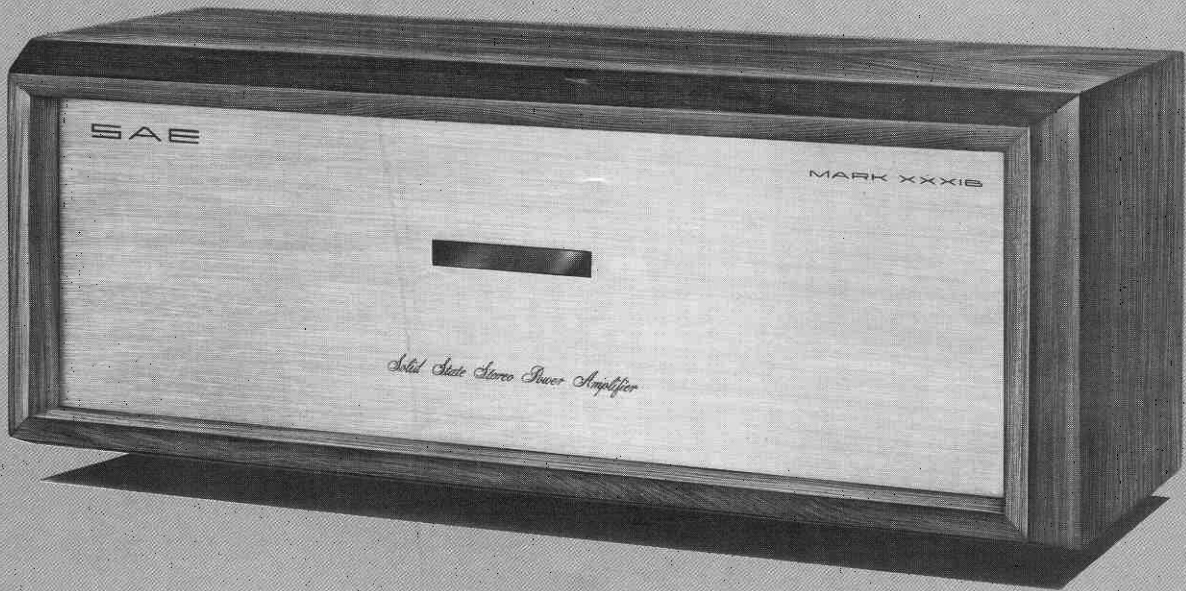

SAE

Components for the Connoisseur

MARK XXXIB CIRCUIT DESCRIPTION

Each channel of the MARK XXXIB is an **all** complementary amplifier powered with symmetrical +40V and -40V power supplies. Each channel comprises parallel-fed complementary differential inputs pairs, complementary driver stages, and complementary Darlington output stages. A portion of the output signals, determined by R13 (3.9K Ohms) and R14 (200 Ohms), is fed back to the negative inputs of the 2 complementary differential input amplifiers which results in an overall gain of 25.5dB (19 X voltage amplification).

Minimum DC offset voltage at the MARK XXXIB speaker output terminals is provided by balanced (matched) 100KOhm resistors (R2, R3, R11, R12, R52, R53, R61, R62) from base-to-ground, at the inputs of the complementary differential amplifiers.

Excessive input signals are limited at the input to the MARK XXXIB by back-to-back diodes (D1, D2, D51, D52) connected between the 2 differential inputs of the complementary input amplifiers.

The common emitter resistors in each of the complementary differential input amplifiers are tied to the opposite ends of a 51V zener diode (D7, D57) which provides a regulated current supply for the complementary differential input amplifiers. Because this regulator diode is fed through 2K-Ohm resistors from the +B and -B power supplies, it will float or "ride" in conjunction with a portion of the input audio signal.

The DC-coupled complementary driver transistors (Q5, Q6, Q55, Q56) have 62-Ohm emitter resistors (R15, R16, R55, R56) which also feed overload-protection control transistors (Q7, Q8, Q57, Q58). These overload transistors are, in turn, driven by a portion of the voltage across (R31, R32, R81, R82) which is proportional to the output transistor current. If less than a 4-Ohm load is driven by the MARK XXXIB, high-signal currents will cause the overload-protection transistors to conduct, thus sinking the driver-transistor emitters which will limit the signal to the output transistors. The speaker-load value that will initiate protection is determined by the resistor-diode network in the base circuit of the protection transistors as well as by its V_{BE} characteristics.

Bias voltage for the complementary Darlington output stages is provided by an integrated-circuit transistor array (Q11, Q61). A bias voltage control (R20, R70) is provided to adjust for minimum distortion. Due to close thermal contact of the bias IC to the output-transistor heat sink, the bias voltage will track accurately with the bias-voltage needs of the output transistors to maintain minimum crossover notch at all operating temperatures. This bias-voltage IC also assures no possibility of output-transistor thermal runaway.

A thermal-sensitive circuit breaker is wired in series with the power transformer primary and will open if the heat sink becomes excessively hot.

Harmonic Distortion (1KHz) vs. Power (2 Channels Driven)

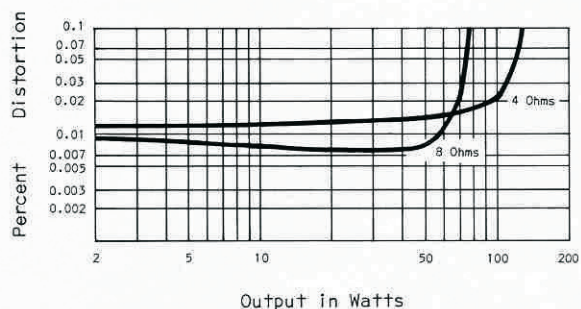

Intermodulation Distortion vs. Power

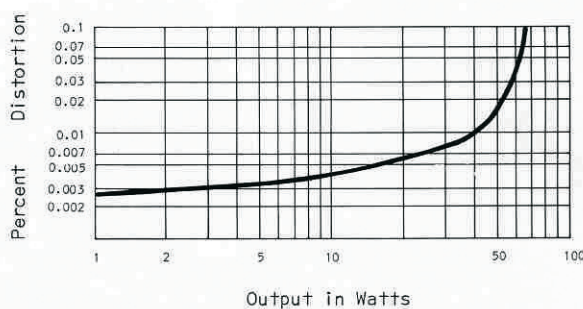

SAE 22-0004 MK 31B POWER SUPPLY BD. PARTS LAYOUT
17-0025

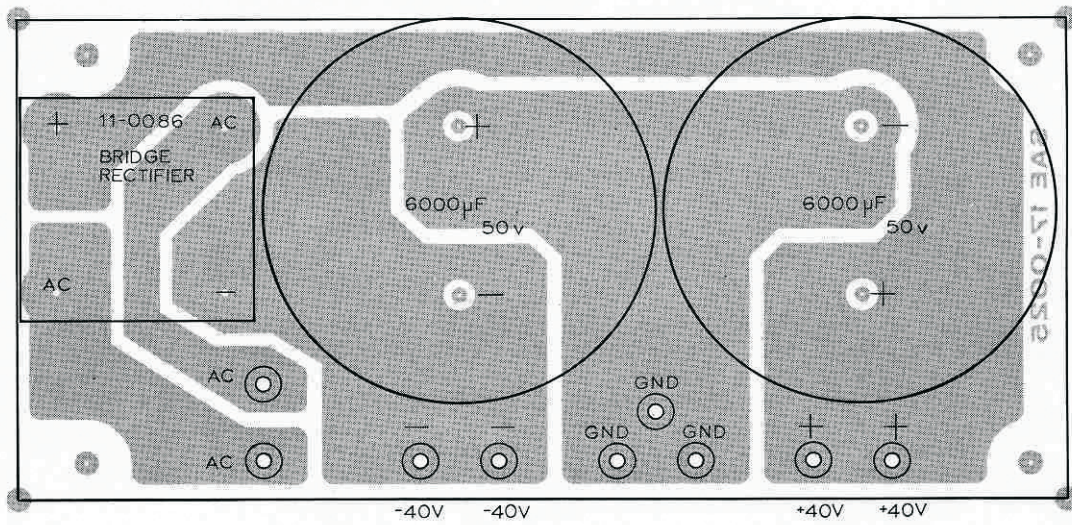

POWER SUPPLY P.C. BOARD ASSY. (22-0004)

QTY. OR REF. NO.	DESCRIPTION	PART NUMBER
	CAPACITORS	
C22,23	6000µF 50V	09-0047
	SEMICONDUCTORS	
1	Bridge Rectifier 6A	11-0136
	HARDWARE & MISC.	
8	P.C. Board Terminal	18-0082
4	Standoff Swaged #6-32 X ¼"	19-0092

MISCELLANEOUS PARTS

QTY.	DESCRIPTION	PART NUMBER
1	MDL 2½ Amp. Slo-Blo Fuse	12-0007
1	Pilot Lamp 14V	16-0002
1	Front Panel, Gold Metal	17-0013
1	Sub Panel, Blk. Metal	17-0014B
1	Top Cover Blk. Metal	17-0015B
1	Bot. Cover, Blk. Metal	17-0016C
1	Center Sub Panel, Blk. Metal	17-0017E
1	Large Heat Sink, Blk. Metal	17-0018
1	Small Heat Sink, Blk. Metal	17-0019
1	Rear Panel, Blk. Metal	17-0020
1	Tstr. Cover, Blk. Metal	17-0021
1	Lens, Pilot Lamp	17-0023
2	Spacer	17-0106
1	Socket, Pilot Lamp	18-0011
9	Connector, Pin	18-0028
1	Fuse Holder	18-0030
2	Speaker Terminal Post, Blk.	18-0031
2	Speaker Terminal Post, Red	18-0032
2	Lug, Ring	18-0054
2	Input Jack	18-0065
2	Wire Butt Connector	18-0068
1	Line Cord Strain Relief	18-0072
3	Standoff #6-32 X ¼" X ¼" Lg.	19-0081
3	Standoff #6-32 X ¼" X ½" Lg.	19-0082
3	Standoff #6-32 X ¼" X 1" Lg.	19-0085
1	A.C. Line Cord	21-0111

MARK XXXIB AMPLIFIER REPAIR HINTS

DISASSEMBLY:

1. To remove the top cover, unscrew 10 screws (6 on top and 2 on either end).
2. To remove the amp module, unscrew 9 screws: 3 along the bottom rear of the chassis, one in front of each of the two rear feet, one on either rear side, and two on the front top of the circuit board.
3. The transistor cover may be removed by unscrewing 3 screws along the top center of the heat sink.

REPAIRING:

1. If the Mark XXXIB amplifier is not operating properly or blew the power fuse, use an Ohmmeter to measure the resistance from the NPN output-transistor collector case to the output terminal of the appropriate channel. When making this measurement, connect the positive lead of the Ohmmeter to the output terminal. This reading should be **higher** than 500 Ohms. If this resistance reading is **less** than 500 Ohms, it is likely that the transistor is defective and should be replaced. (Refer to paragraph 6).
- Repeat with the PNP output transistors, but this time connect the positive lead of the Ohmmeter to the transistor collector case.
2. To evaluate the condition of the bias IC, short the Mark XXXIB input jacks and monitor the DC voltage across the 0.2-Ohm, 5W resistors (R31, R32, R81, R82) in the output-transistor emitters. This DC voltage should not exceed 0.1V when the amplifier is operated with full-line voltage. However, when a circuit malfunction is suspected, use a Variac to apply only 10% (approximately) of the full supply voltage (12-15V) to check for this condition. If excessive DC voltages are measured across the 0.2 Ohm resistor, replace the bias IC. Also, check the driver transistor condition as described in step 3 below.
 3. Check for burned resistors on the drive-circuit board, especially the 62-Ohm (R15, R16, R65, R66) and 10-Ohm resistors (R17, R18, R67, R68). If any resistors appear faulty, then use an Ohmmeter to check the condition of the driver transistors, (Q5, Q6, Q55, Q56) and the protection transistors (Q7, Q8, Q57, Q58) for either collector-to-emitter or base-to-collector shorts.
- (These resistance readings should each exceed 100 Ohms). If any resistance reading is too low, replace the faulty transistor.
4. With no output load on the amplifier, increase the supply line voltage to rated voltage. Now measure the amplifier-output DC offset voltage. This voltage should not exceed $\pm 0.5V$. If the offset voltage approaches +40V or -40V, then check the 1.2 Ohm ground-return resistor (R19, R69) for continuity. If defective, replace this resistor. If excessive offset voltage still persists, check the input differential-amplifier pairs, (Q1, Q2, Q3, Q4, Q51, Q52, Q53, Q54) to verify that none are defective.
 5. Adjust the output-transistor bias controls (R20, R60) on the bottom of the drive circuit board for 2.1V DC measured from base-to-base of the output transistors. If possible, the bias should also be readjusted to achieve between .03% to .04% harmonic distortion at 20KHz with an 8-Ohm load at 1 Watt (2.8V RMS) output.
 6. When replacing output transistors, care must be taken that silicone heat-transfer compound (#20-0045) is applied to both sides of the plastic Therafilm transistor insulator (#18-0075). Only a thin film is required; however, it is important that the **entire** surface area is covered. It is also important that the area beneath the transistor be kept clean (except for the heat compound) so that there are no foreign objects such as metal filings which might puncture the plastic insulator. Finally, tighten the output transistor securely to the heat sink. To insure that the heat sink performs its heat-transfer function properly, **retighten** the transistor mounting screws after the amplifier has been allowed to become warm after operating under power.
- NOTE:** Due to the extremely wide bandwidth of the amplifier, 200KHz R.F. fed directly into the inputs may destroy the output transistors. Therefore, under no circumstances, should the input cable be plugged into the MKXXXIB input while the amplifier is operating. Under no circumstances, should the amplifier be checked to ascertain if it is operating by touching the input lead with your finger. Your body acts as an efficient antenna and can transfer an excessive amount of RF to the amplifier.

Please address all inquiries to:

S A E, INC., CUSTOMER SERVICE DEPARTMENT
P.O. BOX 60271, TERMINAL ANNEX • LOS ANGELES, CALIFORNIA 90060

SAE MK31B STEREO AMPLIFIER
BLOCK DIAGRAM

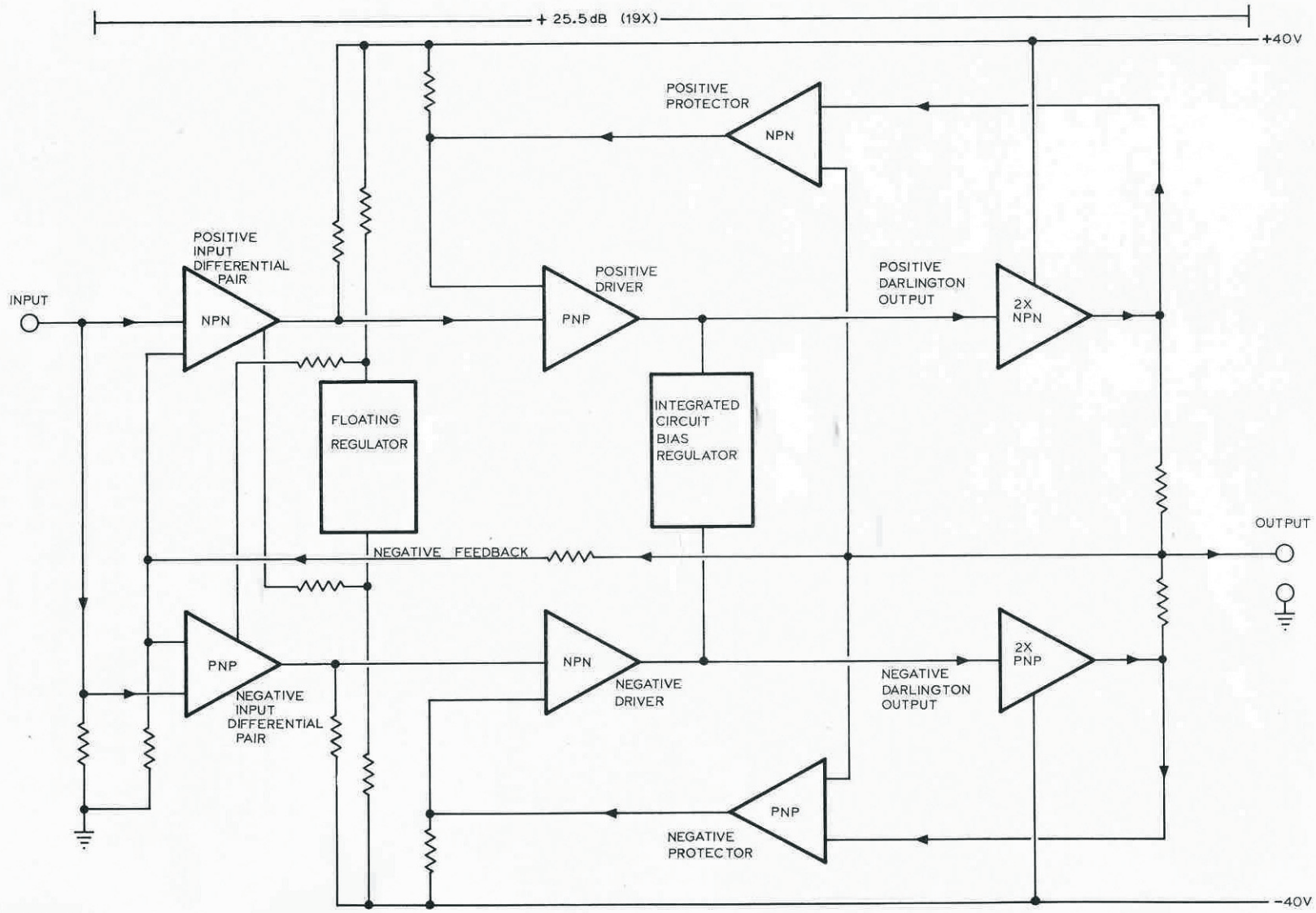

SPECIFICATIONS MARK XXXIB

RMS (MIN) CONTINUOUS POWER
OUTPUT PER CHANNEL 10Hz TO
30KHz (BOTH CHANNELS DRIVEN)

4 Ohms: 75 Watts @ 0.2% Harm. Dist.
8 Ohms: 50 Watts @ 0.1% Harm. Dist.
16 Ohms: 35 Watts @ 0.1% Harm. Dist.

T.H.D. (HARMONIC DISTORTION)
FROM 20Hz TO 20KHz AT 1/4W
TO RATED POWER.

4 Ohms: 0.2% Max.
8 Ohms: 0.1% Max.
16 Ohms: 0.1% Max.

IM (INTERMODULATION DISTORTION)
FROM 1/4W WITH ANY 2 MIXED
FREQUENCIES BETWEEN 20Hz AND
20KHz AT 4/1 VOLTAGE RATIO.

4 Ohms: 0.1% Max.
8 Ohms: .05% Max.
16 Ohms: .05% Max.

FREQUENCY RESPONSE AT 1 WATT

±1dB 1Hz to 100KHz.

NOISE

100dB below rated power

TRANSIENT RESPONSE OF ANY
SQUARE WAVE.

2.5 Microseconds rise and fall time.

STABILITY

Unconditionally stable with any type of load
or no load including full-range electrostatic
loudspeakers.

DAMPING FACTOR

150 Min (100Hz)

INPUT SENSITIVITY

1.0V RMS for rated power output (8 Ohms)

INPUT IMPEDANCE

50K Ohms

SLEW RATE

40 Volts-per-µsec

SEMICONDUCTOR COMPLEMENT

20 transistors (4 Darlington), 12 diodes

OVERLOAD PROTECTION

1) Low-impedance electronic-sensing circuit
limits with load impedance below 2 Ohms
without limiting loads of 4 Ohms or higher
(or reactive loads such as electrostatic
speakers.)

2) Thermal sensing of abnormal heat-sink
temperature.

INTERNAL ADJUSTMENTS

Output-bias adj.

POWER REQUIREMENTS

110-125V, 50Hz/60Hz: 25 Watts @ idling to 300
Watts @ rated out.

SHIPPING WEIGHT

18 pounds (8.2Kg)

DIMENSIONS

Front Panel: 15in. (38.1cm)W, X 4.75in (12.1cm)H.
Chassis: 8in. (20.3cm)D.

WALNUT CABINET

WC-31B (not included)

Power Bandwidth

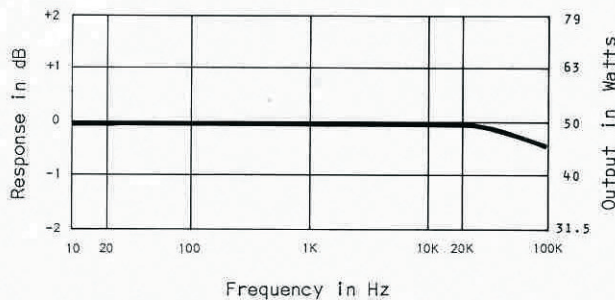

Harmonic Distortion vs. Frequency

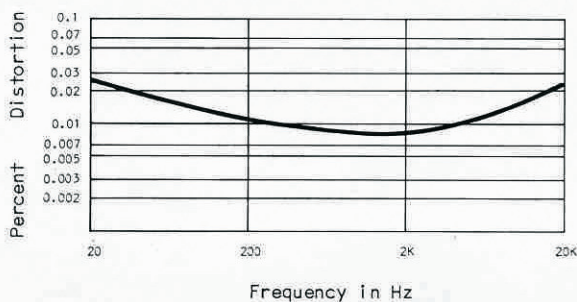

Frequency Response
1 Watt Output

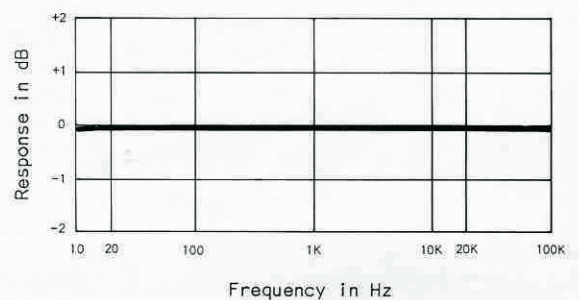

SPECIFICATIONS MARK XXXIB

RMS (MIN) CONTINUOUS POWER OUTPUT PER CHANNEL 10Hz TO 30KHz (BOTH CHANNELS DRIVEN)

4 Ohms: 75 Watts @ 0.2% Harm. Dist.
8 Ohms: 50 Watts @ 0.1% Harm. Dist.
16 Ohms: 35 Watts @ 0.1% Harm. Dist.

T.H.D. (HARMONIC DISTORTION) FROM 20Hz TO 20KHz AT 1/4W TO RATED POWER.

4 Ohms: 0.2% Max.
8 Ohms: 0.1% Max.
16 Ohms: 0.1% Max.

IM (INTERMODULATION DISTORTION) FROM 1/4W WITH ANY 2 MIXED FREQUENCIES BETWEEN 20Hz AND 20KHz AT 4/1 VOLTAGE RATIO.

4 Ohms: 0.1% Max.
8 Ohms: .05% Max.
16 Ohms: .05% Max.

FREQUENCY RESPONSE AT 1 WATT

±1dB 1Hz to 100KHz.

NOISE

100dB below rated power

TRANSIENT RESPONSE OF ANY SQUARE WAVE.

2.5 Microseconds rise and fall time.

STABILITY

Unconditionally stable with any type of load or no load including full-range electrostatic loudspeakers.

DAMPING FACTOR

150 Min (100Hz)

INPUT SENSITIVITY

1.0V RMS for rated power output (8 Ohms)

INPUT IMPEDANCE

50K Ohms

SLEW RATE

40 Volts-per-µsec

SEMICONDUCTOR COMPLEMENT

20 transistors (4 Darlington), 12 diodes

OVERLOAD PROTECTION

1) Low-impedance electronic-sensing circuit limits with load impedance below 2 Ohms without limiting loads of 4 Ohms or higher (or reactive loads such as electrostatic speakers.)

2) Thermal sensing of abnormal heat-sink temperature.

INTERNAL ADJUSTMENTS

Output-bias adj.

POWER REQUIREMENTS

110-125V, 50Hz/60Hz: 25 Watts @ idling to 300 Watts @ rated out.

SHIPPING WEIGHT

18 pounds (8.2Kg)

DIMENSIONS

Front Panel: 15in. (38.1cm)W, X 4.75in (12.1cm)H.
Chassis: 8in. (20.3cm)D.

WALNUT CABINET

WC-31B (not included)

Power Bandwidth

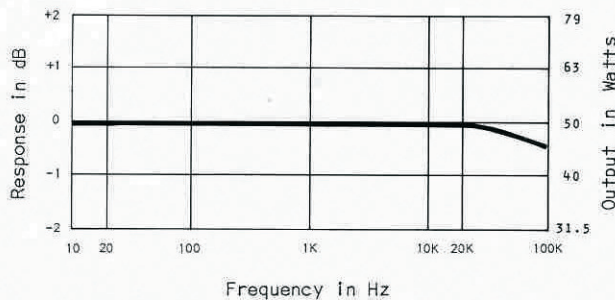

Harmonic Distortion vs. Frequency

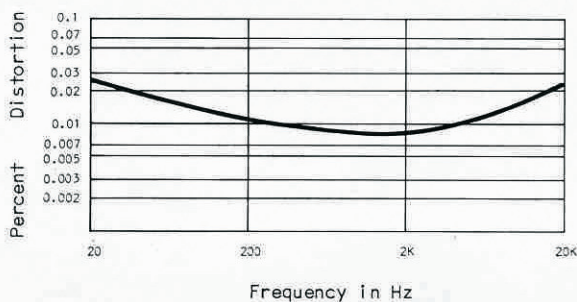

Frequency Response 1 Watt Output

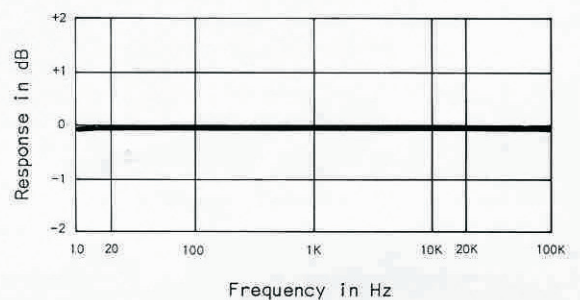

EXPORT

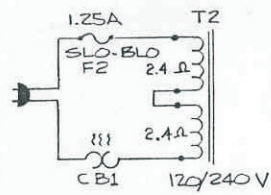

SEMICONDUCTORS, BOTTOM VIEWS

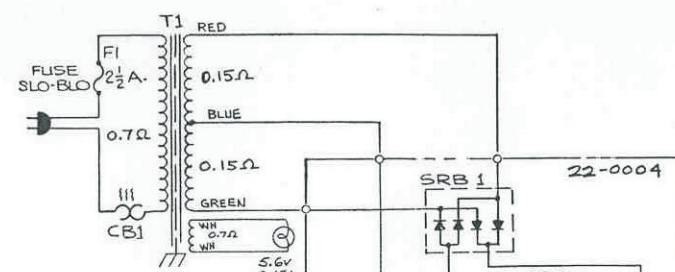

SYM	REVISION
A	CHANGED Q5,6,7,8 ON BOTH CHANNELS.
B	R27 WAS 300Ω.
C	ADDED P.C.#1598
D	R19 WAS 2.2Ω
E	R34 WAS ADDED 10Ω 1/2W
F	REFER TO ECO #59

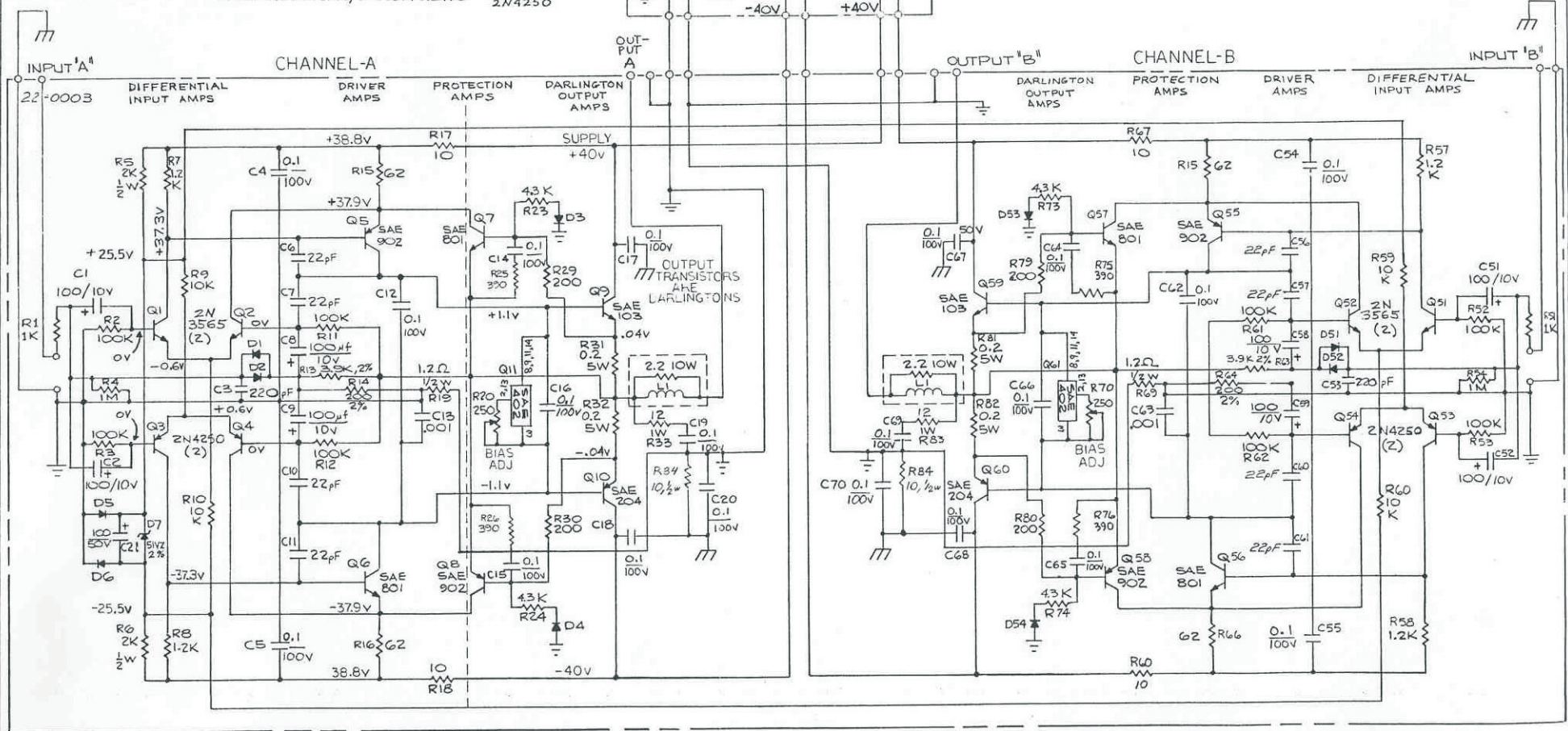

- NOTES:
1. ALL DIODES SIMILAR TO IN4148/IN914.
 2. D5, D6, D7 & C22 & R5, R6 COMMON TO BOTH CHANNELS.
 3. C21 MAY BE OMITTED FROM CERTAIN UNITS.

4 - VOLTAGE VALUES GIVEN ARE AT 15mA QUIESCENT CURRENT.

PART NO.	1800	PART NAME	SCHMATIC-AMPL
SCIENTIFIC AUDIO ELECTRONICS, INC. P.O. BOX 20271 TERMINAL ANNEX 801 E. MARY ST. LOS ANGELES, CALIF. 90008			
MATERIAL		FINISH	
SCALE	DRAWN BY	APPROVED	USED ON
	K. Galt		XXXI B

